

User Manual

Profino Revolution Lite
Ref. 6714



PATENTED TECHNOLOGY

SW Version 1.8.1.R

CONTENTS

1. INTRODUCTION	3
1.1. Product description	3
1.2. Typical installation	3
1.3. Package contents	3
1.4. Hardware installation	4
1.5. Mounting the Profino Revolution Lite	4
1.6. Configuring the Profino Revolution Lite	5
2. TECHNICAL SPECIFICATIONS	12
3. BLOCK DIAGRAM	13
4. SAFETY INSTRUCTIONS	14
5. CONDITIONS OF WARRANTY	15

No part of this manual may be copied, reproduced, transmitted, transcribed or translated into any language without permission.

Unitron reserves the right to change the specifications of the hardware and software described in these manuals at any time.

Unitron cannot be held liable for any damages resulting from the use of this product. Specifications are subject to change without notice. 02/22

© Unitron - Frankrijklaan 27 - B-8970 Poperinge - Belgium

T +32 57 33 33 63 **F** +32 57 33 45 24

sales@unitrongroup.com

www.unitrongroup.com

1. INTRODUCTION

1.1. Product description

The Johansson Profino Revolution Lite is an easy to use programmable filter amplifier and convertor for terrestrial signals. The module optimizes terrestrial VHF/UHF signals from multiple inputs. The state-of-the-art programmable filter amplifier has no equivalent on the market due to its revolutionary technology:

- **Smart & Automatic CHANNEL SCAN**
- Can process and convert more than 50 channels (consisting out of 32 filters, each up to 6 MUXes wide)
- Can process S-Band output channels
- 5G LTE Protection (694MHz)
- Sharpest filters on the market (50 dB on adjacent channels)
- Real-time AGC on all individual multiplexes
- Complete flexibility in assigning filters from any input. Each channel can be frequency shifted to any other channel in the VHF or UHF band (Flex Matrix)
- To avoid unauthorized persons changing the settings, all Profiler products can be locked with a security code
- Made in Europe, for worldwide application
- 3 VHF/UHF inputs / 32 filters / AGC / 12-24 V remote power
- Powered via output F-connector
- Product dimensions (H X W X D): 165mm x 190mm x 59mm

1.2. Typical installation

The Profino Revolution Lite can be used to provide high quality TV signals in a wide range of projects, both in the hospitality as in the residential market. Typical buildings or infrastructures where the Profino Revolution Lite can be used include, but are not limited to:

- Large and small hotels, hostels, bed and breakfasts, holiday parks
- Hospitals, rest homes, prisons, settlements
- Large and small multi-dwelling units

1.3. Package contents

- 1 Profino Revolution Lite (ref. 6714)
- Not included: Power Supply ref. 2438 (only included in KIT6714)

1.4. Hardware installation

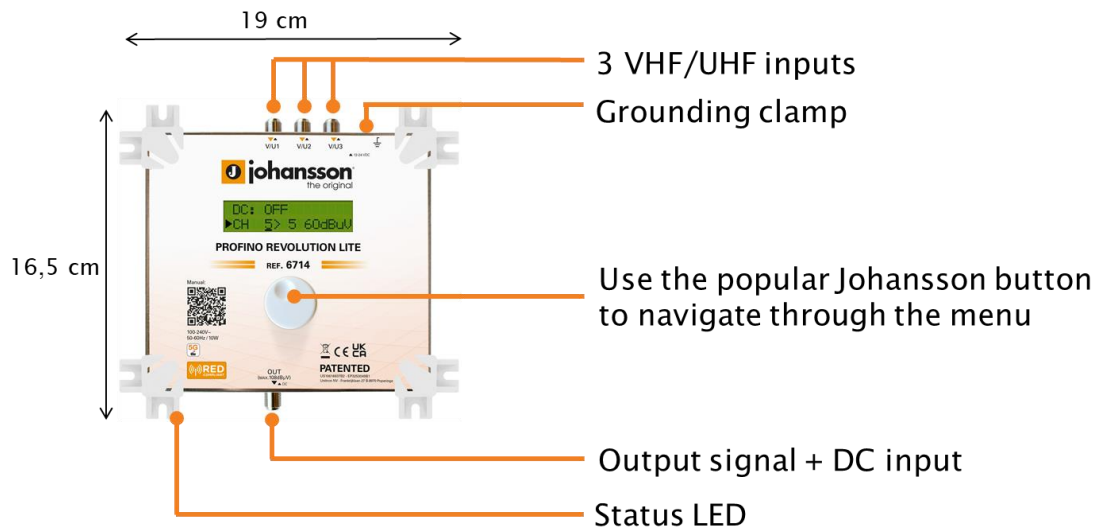
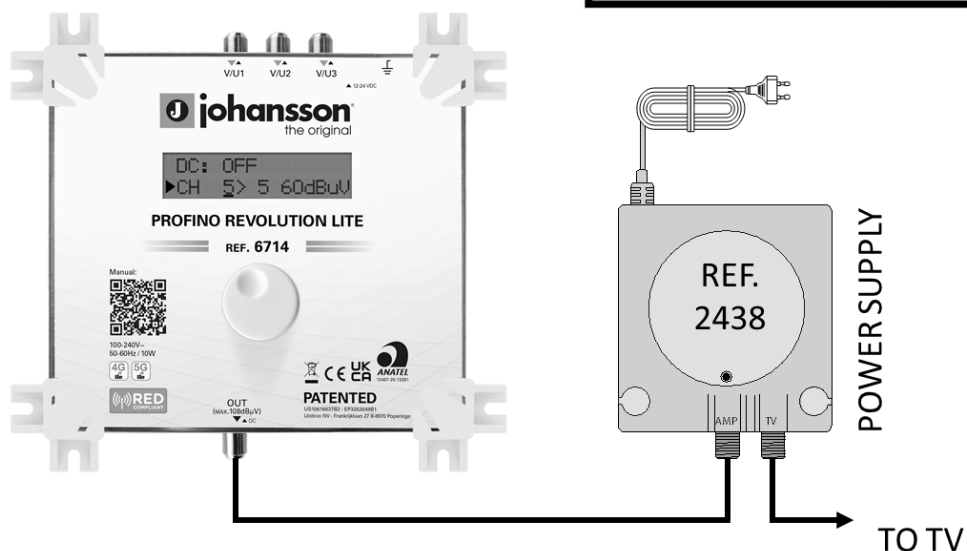
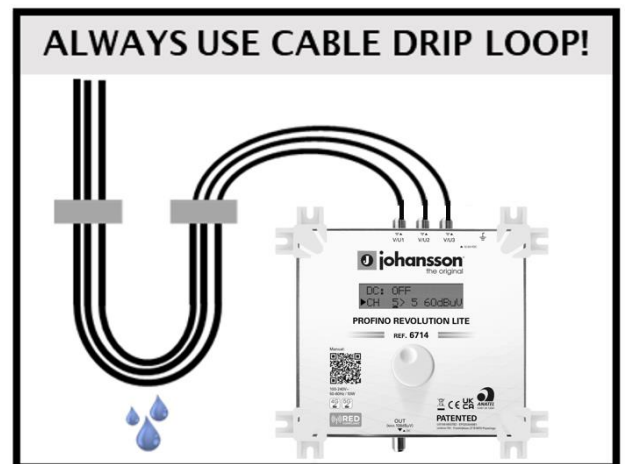

FIGURE 1: TOP VIEW OF PRODUCT

1.5. Mounting the Profino Revolution Lite



- **Important:** Mount the module vertically to a wall in a well-ventilated room and leave a minimum space of 15 cm around the product to guarantee a maximum ventilation of the product
- Connect an earth wire to the grounding clamp
- Connect the inputs to the Profino Revolution Lite
- Connect a coaxial cable to the output connector for distribution of the signal
- Power the device via the output (use the Johansson Power Supply ref. 2438)
- Configure the device using the rotary button



1.6. Configuring the Profino Revolution Lite

NAVIGATING THROUGH THE MENU

Use the Johansson rotary/push button to navigate through the menu. This is very straightforward and simple. The table below shows how the rotary/push should be used:

	<p>Push the button 2s to enter the basic configuration.</p> <p>Push the button to confirm your selections.</p>
	<p>When rotating the button, you scroll through the different screens.</p>

MENU OVERVIEW

	CHANNEL SCAN	INPUT V/U 1 - 3	OUTPUT	ADVANCED	EXIT	
◀▶	START	PRE-AMPLIFIER	LEVEL	LANGUAGE	LOCK	▶◀
◀▶	DUPLICATCH	DC	VHF ATTN	REGION	NO LOCK	▶◀
	REPOWER	ADD CHANNEL		DC VOLTAGE		
				BANDWIDTH		
				S-BAND		
				FW VERSION		
				SERIAL NUMBER		

REGION/COUNTRY SETTINGS





IMPORTANT! Before starting the configuration, it is advised to set the correct region or country. Unpower the unit, push the button and keep pushing the button while you repower the unit. Release the button when the display shows "RESET FINISHED". Now the product is reset and will ask you to enter country or region. This will amongst others determine the channel plan for VHF and UHF and the DC voltage for the inputs (12 or 24V).

DISPLAY READOUT	EXPLANATION
	<p>To activate the correct channel frequency plan, select the country or region where the Profiler Revolution Lite is situated. Rotate to select and confirm by tapping the rotary button.</p> <p>The default setting is Europe. The Profiler Revolution Lite is also operational in the following countries/regions: Australia, Brazil, China, Hongkong, Italia, New-Zealand, Russia, South Africa, UK and USA.</p>









All the following menu items can be accessed without the reset procedure.

Push the rotary button for 2 seconds to access the menu



CHANNEL SCAN

DISPLAY READOUT	EXPLANATION
	Tap the rotary button to enter the channel scan menu
	Scroll down to START and tap the rotary button to start scanning
	<p>Note: If you use an active antenna or mast amplifier, activate the DC before doing the Channel Scan (see next page: DC)</p> <p>Scanning can take up to 1 minute</p>
	<p>When scanning is finished, the number of detected channels will be displayed. Manual changes can still be done afterwards via the Input settings (next section)</p> <p>Tap the rotary button to proceed in the menu</p> <p>Sometimes, there can be transponders on the same frequency coming from different antennas (e.g. CH40 is detected on input 1 and input 2). These are called duplicate channels.</p> <p>DUPLICATCH = When duplicate channels is ON, the weakest of a pair of duplicate channels will be transferred to the LTE band. The strongest of the pair keep its frequency at the output.</p>
	<p>When duplicate channels is OFF, the weakest of a pair of duplicate channels will be rejected.</p> <p>When REPOWER is ON, the device will do a rescan after a power interruption of 6 seconds or less. If a power interruption takes longer than 6 seconds, channel settings will not change.</p> <p>When REPOWER is OFF, the device will never automatically rescan.</p>



INPUT SETTINGS

DISPLAY READOUT	EXPLANATION
	Tap INPUT V/U 1 to enter the menu to configure input 1.
	Rotate the rotary button to scroll down in the submenu of INPUT V/U 1.
	PRE-AMPLI: The internal amplifier is by default ON, only in case of very strong incoming signals (if the strongest channel on that input is higher than 80dBμV), it can be advised to switch this OFF.
	DC: Decide whether the input should provide power to an external amplifier. Choose between OFF or 12 V. <u>Remark:</u> If the external amplifier needs 24 V, you can change this in advanced settings (see further).
	Tap Add Channel to add channel. Up to 6 channels can be added at once.
	First select the starting channel (e.g. CH5) and tap to confirm. Then select the stop channel (e.g. CH7, this means that you will add 3 channels). Tap to confirm. Then you can convert them using the rotary button (e.g. CH5 to CH7 converts to CH8 to CH10) and tap to confirm.
	Some other examples: To add CH5 and convert to CH6, select as follows: 5: 5 → 6: 6 To add CH21-22-23 and convert to CH31-32-33, select as follows: 21:23 → 31:33
	<u>Remark 1:</u> The value 85dBμV (in the bottom right corner) indicates the incoming level of the channel. <u>Remark 2:</u> For EU, Italy and New-Zealand region, Channel 13 (230-240MHz) can be used. CH13 cannot be converted. <u>Remark 3:</u> A star (*) will appear when converting to a different channel bandwidth: e.g. from a 7MHz channel to an 8 MHz channel



For optimal performance we recommend to only add single channels, unless you need to process a lot of channels.

DISPLAY READOUT	EXPLANATION
 <p>21:22→23:24 *84 ▶ 23:23→23:23 *84</p>	<p>To add another (group of) channel(s), scroll down to ADD CHANNEL and tap to confirm. To prevent bad quality or scrambled images, make sure that only one input channel is assigned to one output channel. If 2 channels are assigned to the same output channel, a star (*) will appear.</p>
 <p>21:22→23:24 184 ▶ 25:25→25:25 173</p>	<p>The same applies for adding multiple channels. Make sure that each output channel is selected only once.</p>

To delete a (pair of) channel(s), position the arrow on the channel and press the rotary button 3 seconds.

DISPLAY READOUT	EXPLANATION
 <p>CHANNEL DELETED</p>	<p>To delete a (pair of) channel(s), position the arrow on the channel and press the rotary button 3 seconds.</p>
 <p>◀ INPUT V/U 2 ▶</p>	<p>When you have added all the channels to INPUT V/U 1, and you want to add channels to the other inputs, scroll up to the top of the menu (to INPUT V/U 1), tap the button and scroll to the next input. Repeat the previous steps for all input channels.</p>

OUTPUT SETTINGS

DISPLAY READOUT	EXPLANATION
 <p>▼ OUTPUT LEVEL: 103dBuV</p>	<p>Define the OUTPUT LEVEL of the output signal. Range between 88 dBμV and 108 dBμV (default output level is 98 dBμV). Note: The more channels you select, the less input power you should give (e.g. 99 dBμV for 10 channels).</p>
 <p>LEVEL: 105dBuV ▶ VHF ATTN: 0dB</p>	<p>VHF ATTN: To compensate for cable losses, an attenuator of up to 15 dB can be configured to decrease the VHF (up to 300MHz) output level (compared to the UHF output level (above 300MHz)).</p>

Note: In the OUTPUT menu, you define the output level in dB μ V of the MUX's. The Profiler Revolution has enough gain to guarantee this output level under all input conditions.

ADVANCED SETTINGS



DISPLAY READOUT	EXPLANATION
	<p>The language of the Profiler Revolution can be set to English, Italian, Spanish or French.</p>
	<p>Tap REGION to check to which region/country the Profiler Revolution is set. To change the region/country, a hard reset is required (see instructions above (cfr. REGION/COUNTRY SETTINGS)).</p>
	<p>Define DC VOLTAGE for the inputs, choose between 12V or 24V. This is a global setting for all inputs, each input can then be switched between OFF or this value. (cfr. STEP 2). All countries are set by default on 24V, except UK which is set by default on 12V.</p>
	<p>The filter bandwidth can be changed from -2000 kHz to 0 kHz in steps of 250 kHz. This allows you to optimize the bandwidth of your filter. For instance, a European 8 MHz channel can be changed from 6 to 8 MHz. The default setting is -750 kHz, which is an optimal setting in 95% of the cases.</p> <p>S-Band channels can be activated in Advanced Mode. By default, they are not activated.</p>
	<p>See NOTE below for more explanation.</p>
	<p>Tap FW VERSION to check the firmware version of the device. Tap SERIAL NUMBER to check the serial number of the device. To format the SD CARD, tap FORMAT CARD.</p>

Note: You can convert any single input Channel, to any output Channel position (including output S-channels). But you can only convert a group of input channels to a group of output channels with the same channel spacing.

Some examples:

21:23 → 31:33	Can be converted because groups of channels have same channel spacing
07:07 → S15:15	Can be converted because single channel conversion
07:07 → S35:35	Can be converted because single channel conversion (Even though channel spacing and bandwidth is different)
07:08 → S35:36	Can't be converted because groups of channels have different channel spacing

EXIT SETTINGS

DISPLAY READOUT	EXPLANATION
	<p>To avoid unauthorized people changing the settings, all Profiler products can be locked with a security code.</p>
	<p>Select LOCK and SET LOCK CODE. When the lock code is set, the device will shut down.</p>
	<p>When you restart the device, you will now have to enter the correct lock code. <u>Remark:</u> If you forgot the lock code, you can always use the value 50. This master code is fixed and cannot be changed. If you do not want to work with a lock code, go to EXIT and tap NO LOCK.</p>

2. TECHNICAL SPECIFICATIONS

Profino Revolution Lite 6714		
Inputs	-	3 VHF/UHF (wideband)
Outputs	-	1 main (VHF-S-UHF)
Input frequency range (EU*)	MHz MHz	VHF: 174 – 240 UHF: 470 – 694
Output frequency range (EU*)	MHz	174 – 862
LTE protection	MHz	694 (5G)
Input level	dB μ V dB μ V	VHF: 37** - 109 UHF: 37** - 109
VHF/UHF Output power (60dB/IM3)	dB μ V	114
VHF/UHF Output power (36dB/IM3)	dB μ V	125
VHF/UHF Output power with 1 MUX	dB μ V	108
VHF/UHF Output power with 6 MUX	dB μ V	108
VHF/UHF Output power with 15 MUX	dB μ V	105
VHF/UHF Output power with 32 MUX	dB μ V	102
Add channels	-	Per 1, 2, 3, 4, 5 or 6 MUXes
Number of channels	-	More than 50 (32 filters)
Conversion	-	Yes (from any VHF-UHF channel to any VHF-S-UHF channel)
Gain	dB dB	VHF: >65 UHF: >65
Gain adjustment	dB	Channel AGC
General attenuator	dB	20
VHF attenuator	dB	15
Noise figure	dB	7
Selectivity	dB/1MHz	50
Return Loss	dB	10
Output MER	dB dB	VHF: 35 UHF: 35
ESD protection	-	All inputs
Remote voltage for preamp	V	12 or 24
Remote current	mA	50 (total for the 3 inputs)
Operating temperature	°C	-5 to +50
Power Supply	V _{DC}	12V (use ref. 2438)
Power consumption	W	9
Dimensions	mm	190 x 165 x 59
Weight	kg	0,65

* frequency range can vary slightly according to local channel plan (check REGION settings)

** For 64QAM with code rate 3/4

3. BLOCK DIAGRAM

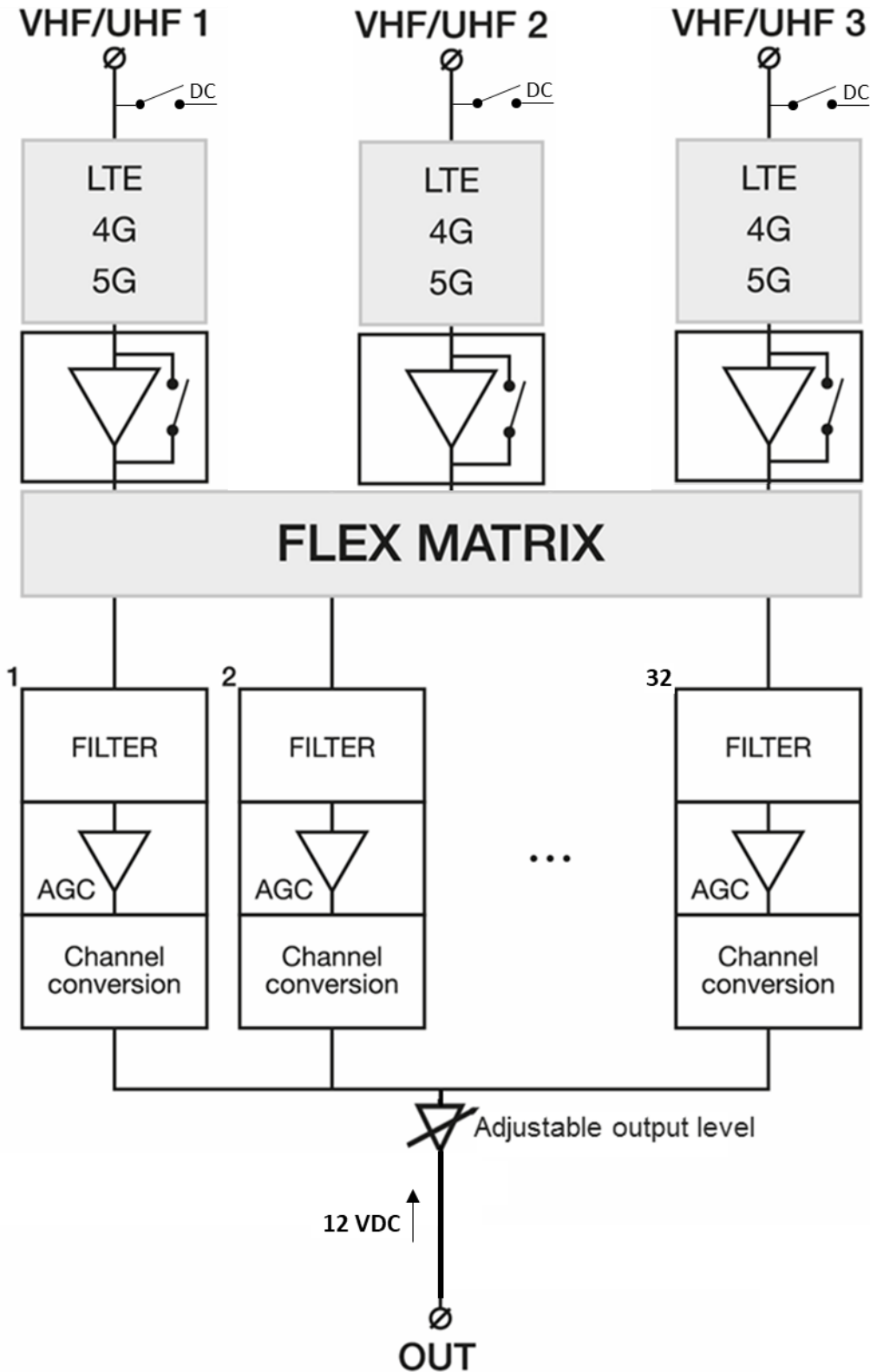

4. SAFETY INSTRUCTIONS



Read these instructions carefully before connecting the unit



To prevent fire, short circuit or shock hazard:

- Do not expose the unit to rain or moisture.
- Install the unit in a dry location without infiltration or condensation of water.
- Do not expose it to dripping or splashing.
- Do not place objects filled with liquids, such as vases, on the apparatus.
- If any liquid should accidentally fall into the cabinet, disconnect the power plug.



To avoid any risk of overheating:

- Install the unit in a well aired location and keep a minimum distance of 15 cm around the apparatus for sufficient ventilation
- Do not place any items such as newspapers, tablecloths, curtains, on the unit that might cover the ventilation holes.
- Do not place any naked flame sources, such as lighted candles, on the apparatus
- Do not install the product in a dusty place
- Use the apparatus only in moderate climates (not in tropical climates)
- Respect the minimum and maximum temperature specifications



To avoid any risk of electrical shocks:

- Connect apparatus only to socket with protective earth connection.
- The mains plug shall remain readily operable
- Pull out power plug to make the different connections of cables
- To avoid electrical shock, do not open the housing of adapter.



Maintenance



Only use a dry soft cloth to clean the cabinet.



Do not use solvent



For repairing and servicing refer to qualified personnel.



Dispose according your local authority's recycling processes

5. CONDITIONS OF WARRANTY

Unitron N.V. warrants the product as being free from defects in material and workmanship for a period of 24 months starting from the date of production indicated on it. See note below.

If during this period of warranty the product proves defective, under normal use, due to defective materials or workmanship, Unitron N.V, at its sole option, will repair or replace the product. Return the product to your local dealer for reparation.

THE WARRANTY IS APPLIED ONLY FOR DEFECTS IN MATERIAL AND WORKMANSHIP AND DOES NOT COVER DAMAGE RESULTING FROM:

- Misuse or use of the product out of its specifications,
- Installation or use in a manner inconsistent with the technical or safety standards in force in the country where the product is used,
- Use of non-suitable accessories (power supply, adapters...),
- Installation in a defect system,
- External cause beyond the control of Unitron N.V. such as drop, accidents, lightning, water, fire, improper ventilation...

THE WARRANTY IS NOT APPLIED IF

- Production date or serial number on the product is illegible, altered, deleted or removed.
- The product has been opened or repaired by a non-authorized person.

NOTE

Date of production can be found in the product's serial number code. The format will either be "YEAR W WEEK" (e.g., 2017W32 = year 2017 week 32) or "YYWW" (e.g., 1732 = year 2017 week 32).



www.unitrongroup.com

UNITRON NV
Frankrijklaan 27
B-8970 Poperinge
Belgium

T +32 57 33 33 63
F +32 57 33 45 24

sales@unitrongroup.com

www.unitrongroup.com



www.unitrongroup.com

UNITRON NV
Frankrijklaan 27
B-8970 Poperinge
Belgium

T +32 57 33 33 63
F +32 57 33 45 24

sales@unitrongroup.com

www.unitrongroup.com